

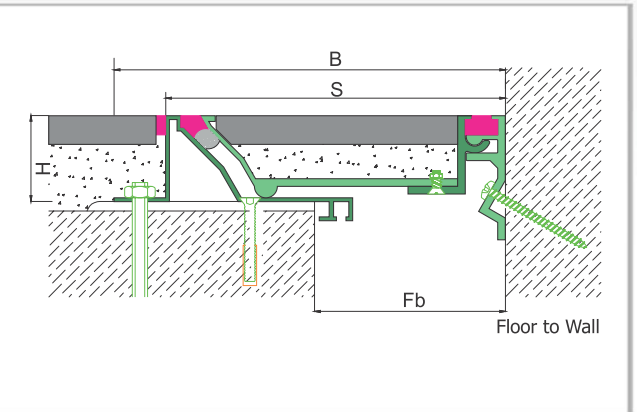

AS A250 model seismic profiles are designed for interior and exterior applications and provide horizontal and lateral shear movements at large openings. They can be applied with many different types of finishes (granite, marble, ceramic etc) at different thicknesses. During the seismic based contractions, specially designed pop-up mechanism ascends the center plate without damaging the finish placed on it and gets back to origin after activity is over. Thermal expansion or contraction doesn't activate the center plate. Almost invisible profiles give a decorative aspect to the spaces with the continuous floor covering view. They are ideal for the places with heavy pedestrian traffic and high earthquake risk. Movement ability can be increased by using long type turnbar.

- Application Areas** : Indoor & Outdoor / Floor
- Ideal for** : Airports, Shopping Malls, Residences, Hospitals, Hotels, Commercial & Public Buildings etc.
- Material** : Mill Finish Aluminum (Anodizing optional), Galvanized Steel
- Aluminum Alloy** : 6063 AA-USA / EN AW 6063
- Optional Supplies** : PE Backing Rod, PU Mastic, Fire Barrier, Waterproof EPDM membrane

SEISMIC

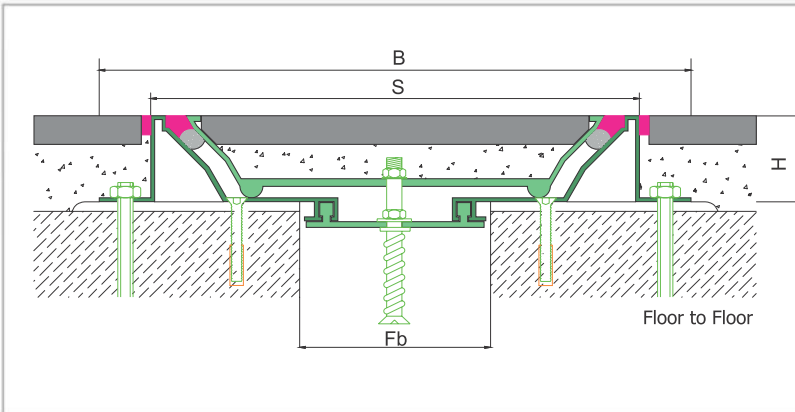
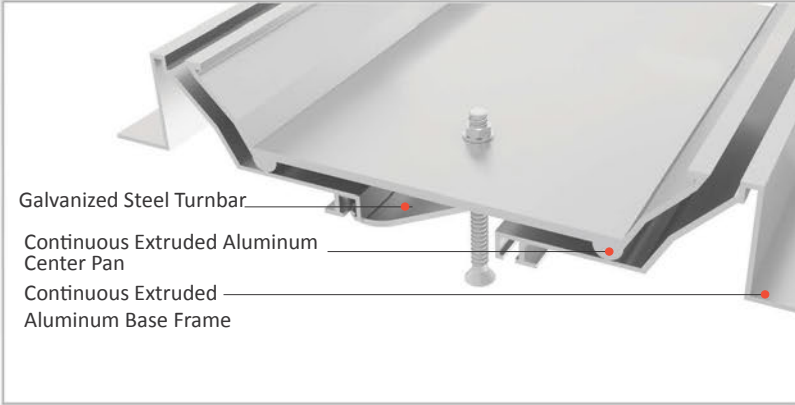

* Visuals are representative and the profile configuration may differ depending on the characteristics requested.

LOCATION	MODEL	GAP (Fb) mm	HEIGHT (H) MM	OVERALL WIDTH (B) mm	VISIBLE WIDTH (S) mm	MOVEMENT (W) mm	LOAD CAPACITY	STANDARD LENGTH (mt)
Floor to Floor	AS A250-075	75	45	290	236	± 22		3
	AS A250-100	100	45	315	261	+30 / -50		3
	AS A250-150	150	45	365	311	+50 / -100		3
	AS A250-200	200	45	415	361	+55 / -150		3
	AS A250-250	250	45	465	411	+55 / -200		3
	AS A250-300	300	45	515	461	+60 / -250		3
	AS A250-400	400	45	616	561	+60 / -330		3

Note: Please ask for different sizes



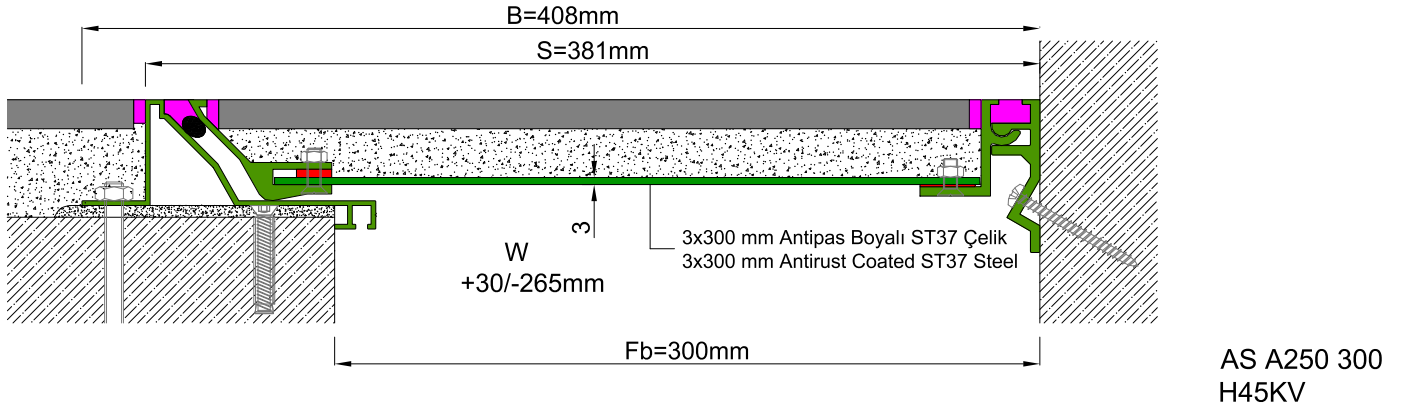
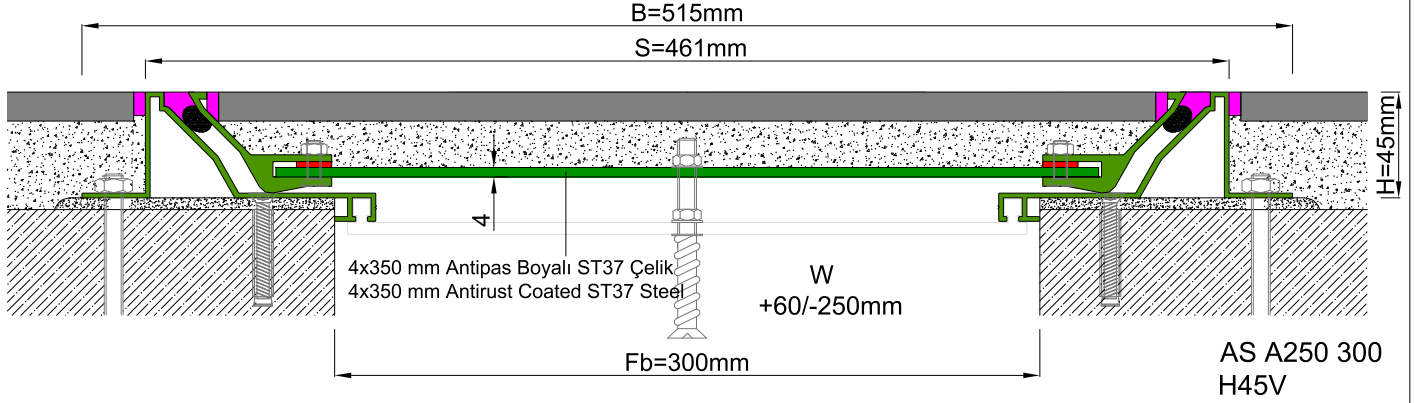

Profil No Profile Number	AS A250 300	AS A250 300K
Fb (mm)	300	300
H (mm) yaklaşık approx.	45	45
W± (mm) yaklaşık approx.	+60/-250	+30/-265
Renk Color	Alüminyum: Natürel, ST37 Çeliği: Antipas Boyalı Aluminum: Natural, ST37 Steel: Antirust Coated	
Malzeme Material	Alüminyum, ST37 Çeliği Aluminum, ST37 Steel	
Standart Uzunluk Standard Length	3	
Yükleme Kapasitesi Load-bearing Capacity	